

# Fuel Cell Electric Vehicle Development of Honda

Takashi Moriya  
Operating Officer  
Honda R&D Co., Ltd.  
September 21, 2010

Blue Skies  
for Children

## Energy Demand & World Oil Production : Forecast

**HONDA**  
The Power of Dreams

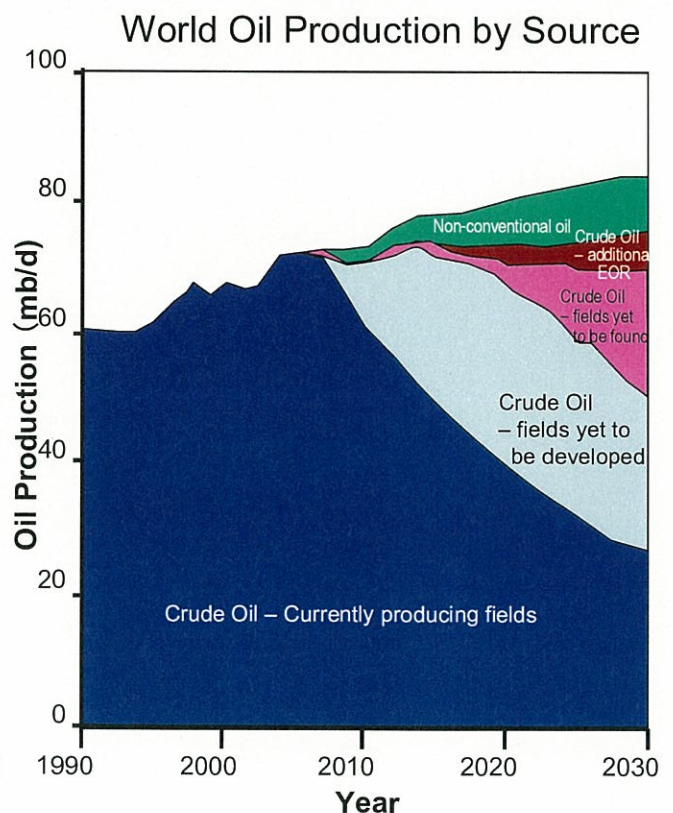
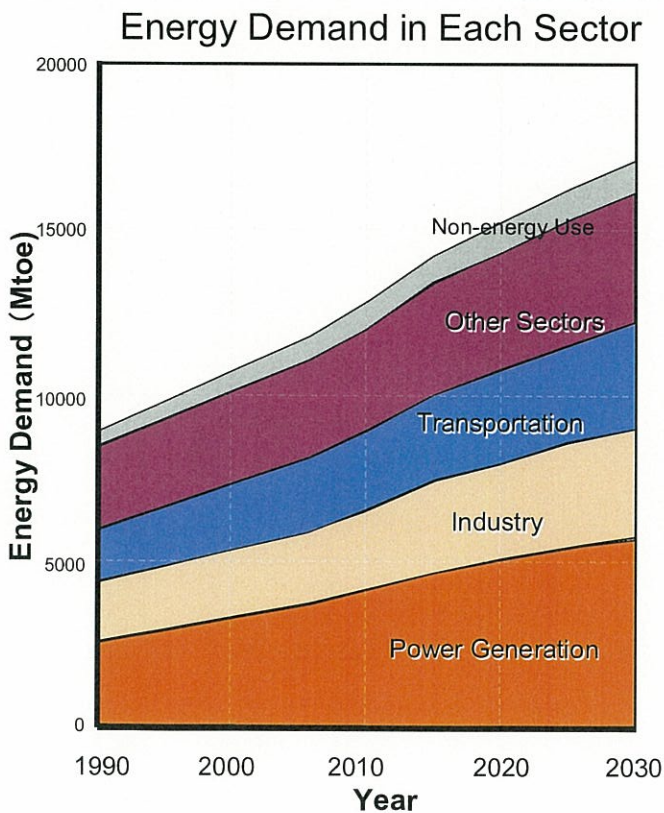

Source: WEO 2008 Reference Scenario

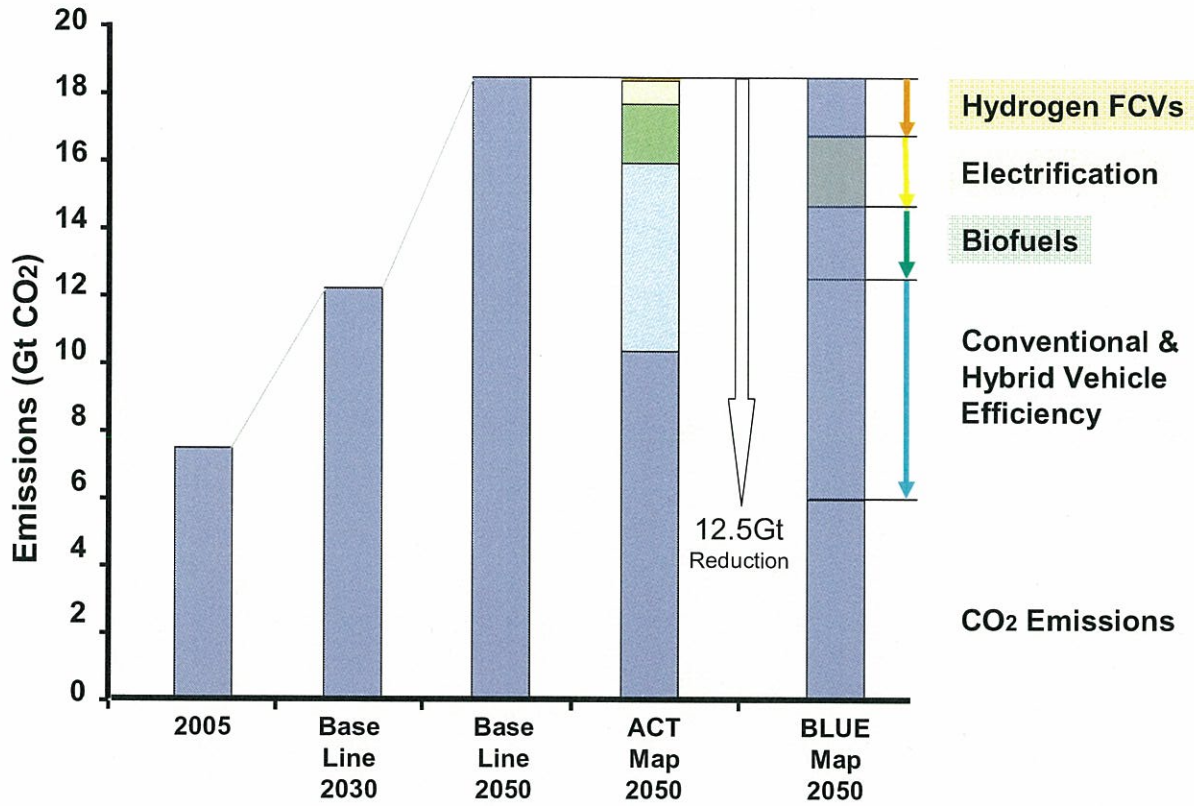

Source: ETP2008

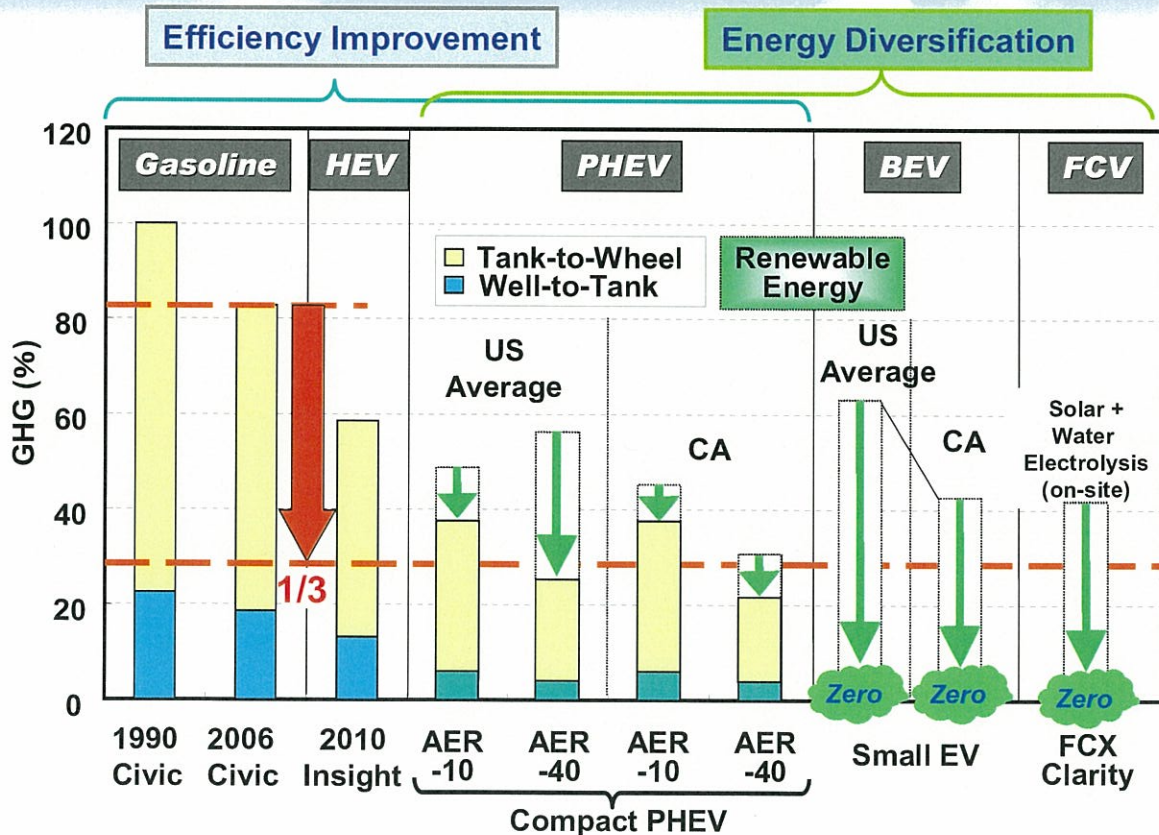

Running on naturally generated hydrogen

## FCEV

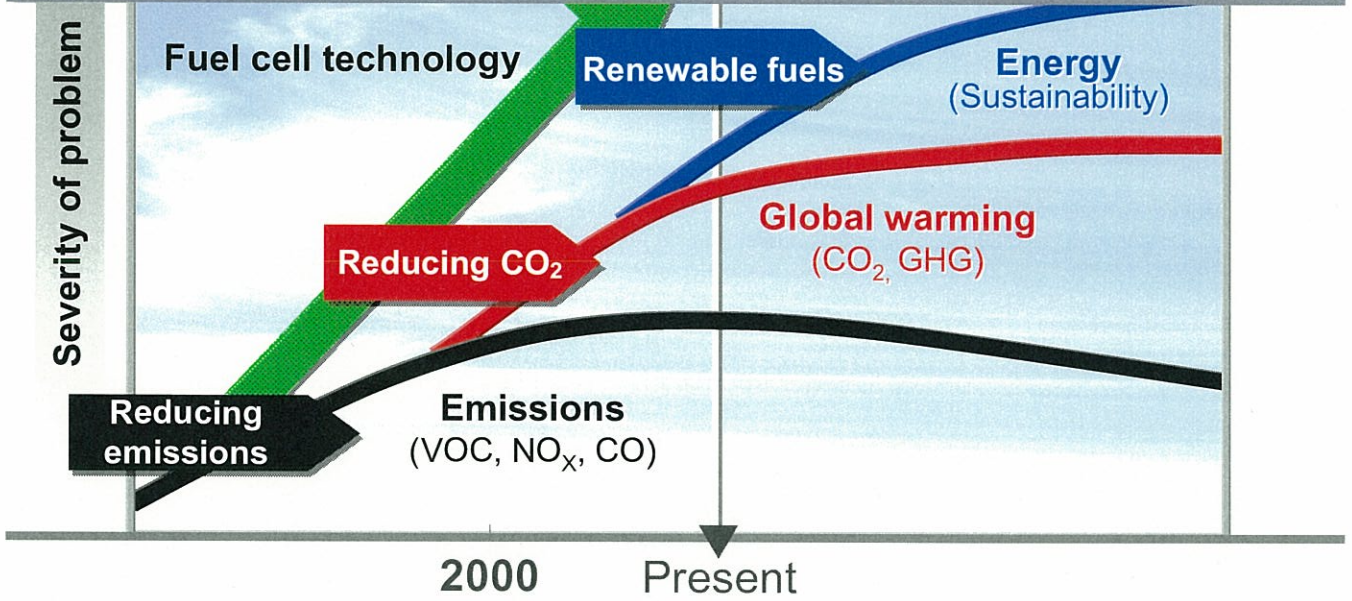

# Development of Fuel Cell Vehicles

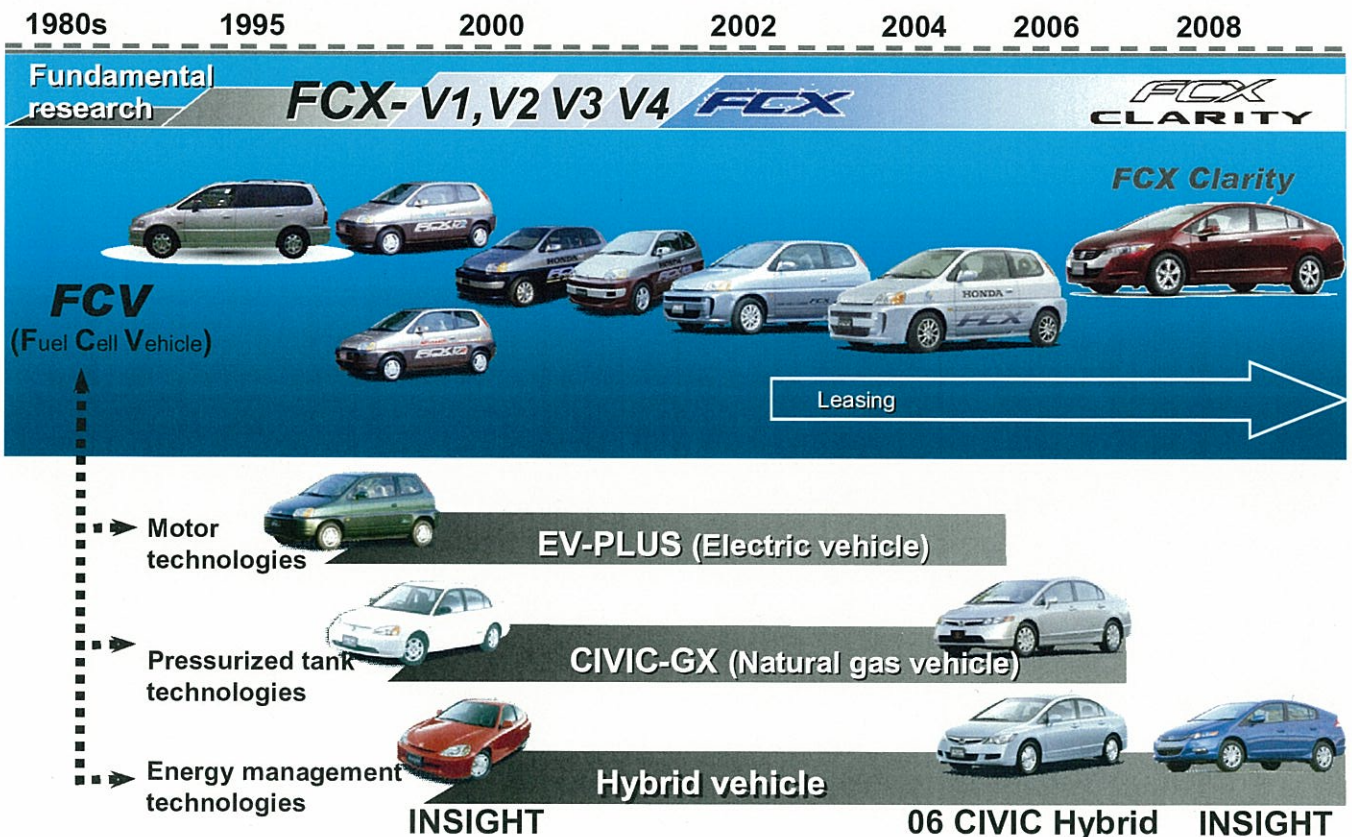

# FCX CLARITY

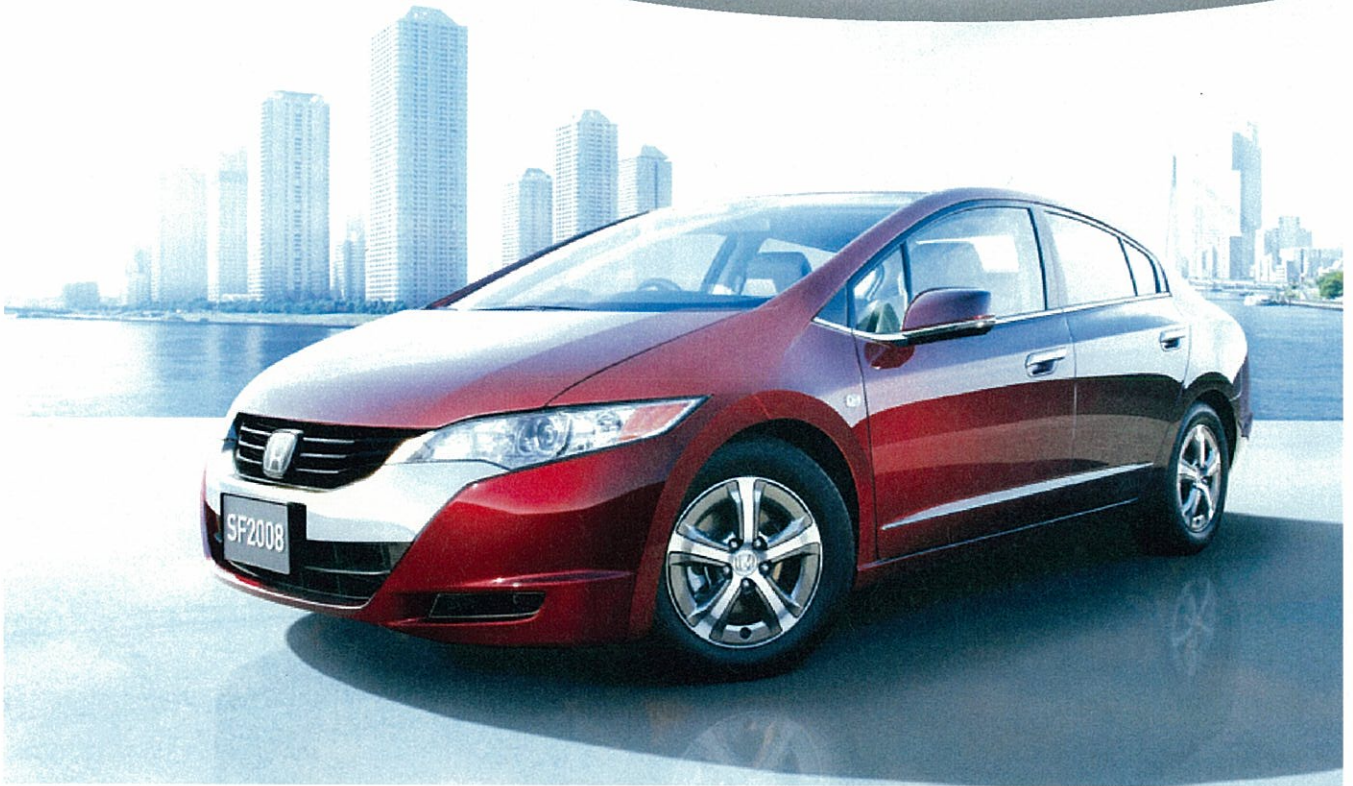

Blue Skies  
for Children

## FCV Powerplant Components

**HONDA**  
The Power of Dreams

### FCX CLARITY

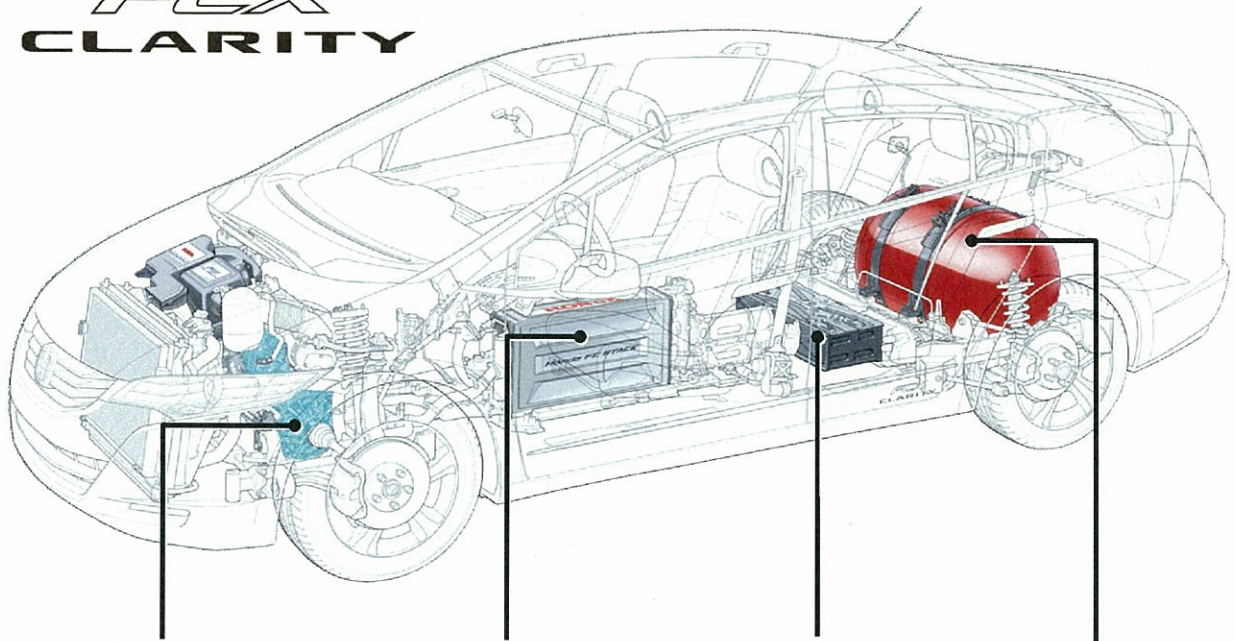

Coaxial Electric Drive  
Motor and Gearbox

V Flow Fuel Cell Stack  
(Center tunnel layout)

Lithium-Ion  
Battery

High-Pressure  
Hydrogen Tank